

深圳市亿显国际科技有限公司 ShenZhen Yes-Display International Technology CO.,LTD.			5.0 寸液晶显示屏 <b>5.0 Inch LCD Display Screen</b>	
File NO.		REV	A/01	<a href="http://www.yes-display.com">http://www.yes-display.com</a>

# SPECIFICATION FOR

**Module:YS-T050012 V1.0**

Designed by	R&D Checked by	Quality Department by	Approved by

## Approval by Customer:

OK

NG, Problem survey

Approved By \_\_\_\_\_

## Revision Record

REV NO.	REV DATE	Contents Before Change	Contents After Change	Note
V1.0	2021/05/17	NEW ISSUE By ABEL;		

深圳市亿显国际科技有限公司 ShenZhen Yes-Display International Technology CO.,LTD.			5.0 寸液晶显示屏 <b>5.0 Inch LCD Display Screen</b>	
File NO.		REV	A/01	<a href="http://www.yes-display.com">http://www.yes-display.com</a>

## Contents

List	Description	Page No.
	Cover	1
	Revision Record	2
	Contents	3
1	Technical parameters	4
2	Block Dimension	5
3	Outline Dimensions	6
4	Input terminal Pin Assignment Description	7
5	LCD Optical Characteristics	8
6	TFT Electrical Characteristics	11
7	Timing Characteristics	13
8	Inspection Standard	16
9	Reliability Test Conditions and Methods	21
10	Cautions and Handling Precautions	23
11	Packing Method	26

深圳市亿显国际科技有限公司 ShenZhen Yes-Display International Technology CO.,LTD.			5.0 寸液晶显示屏 <b>5.0 Inch LCD Display Screen</b>	
File NO.		REV	A/01	<a href="http://www.yes-display.com">http://www.yes-display.com</a>

## 1. Technical parameters

ITEM	STANDARD VALUES	UNITS
LCD type	5.0" TFT	--
Dot arrangement	480(RGB)×854	dots
Color filter array	RGB vertical stripe	--
Display mode	IPS/ Transmission / Normally White	-
Eyes Viewing Direction	12:00	--
Driver IC	ILI9806E-2C	--
Module size	65.30(W)×119.30(H)×2.1(T)(Exclude FPC)	mm
Active area	62.06(W)×110.42(H)	mm
Interface	MIPI 2	--
Operating temperature	-20 ~ +70	°C
Storage temperature	-30 ~ +80	°C
Back Light	White LED*12	--

深圳市亿显国际科技有限公司 ShenZhen Yes-Display International Technology CO.,LTD.			5.0 寸液晶显示屏 <b>5.0 Inch LCD Display Screen</b>	
File NO.		REV	A/01	<a href="http://www.yes-display.com">http://www.yes-display.com</a>

## 2. Block Dimension

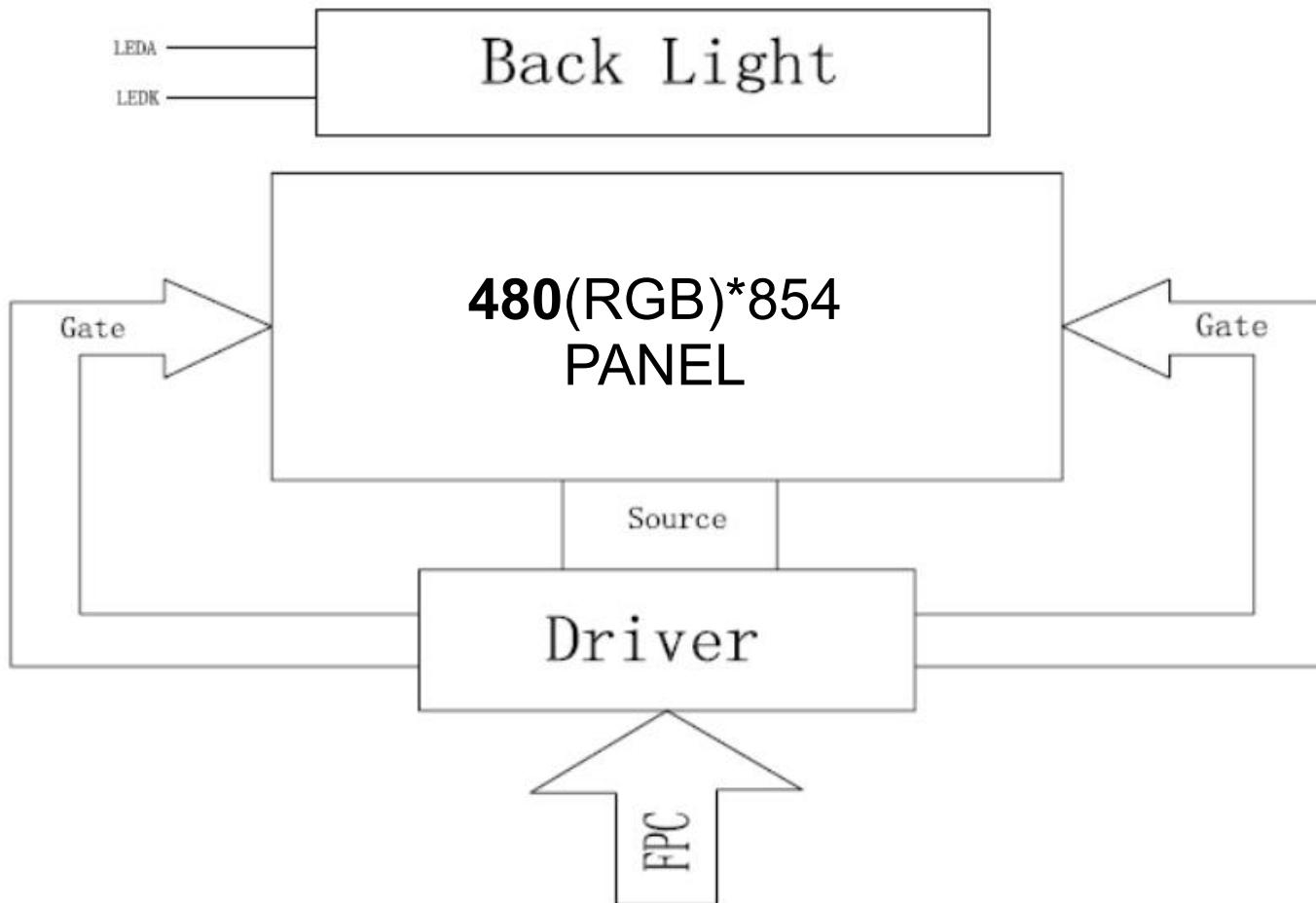

### 3. Outline Dimensions

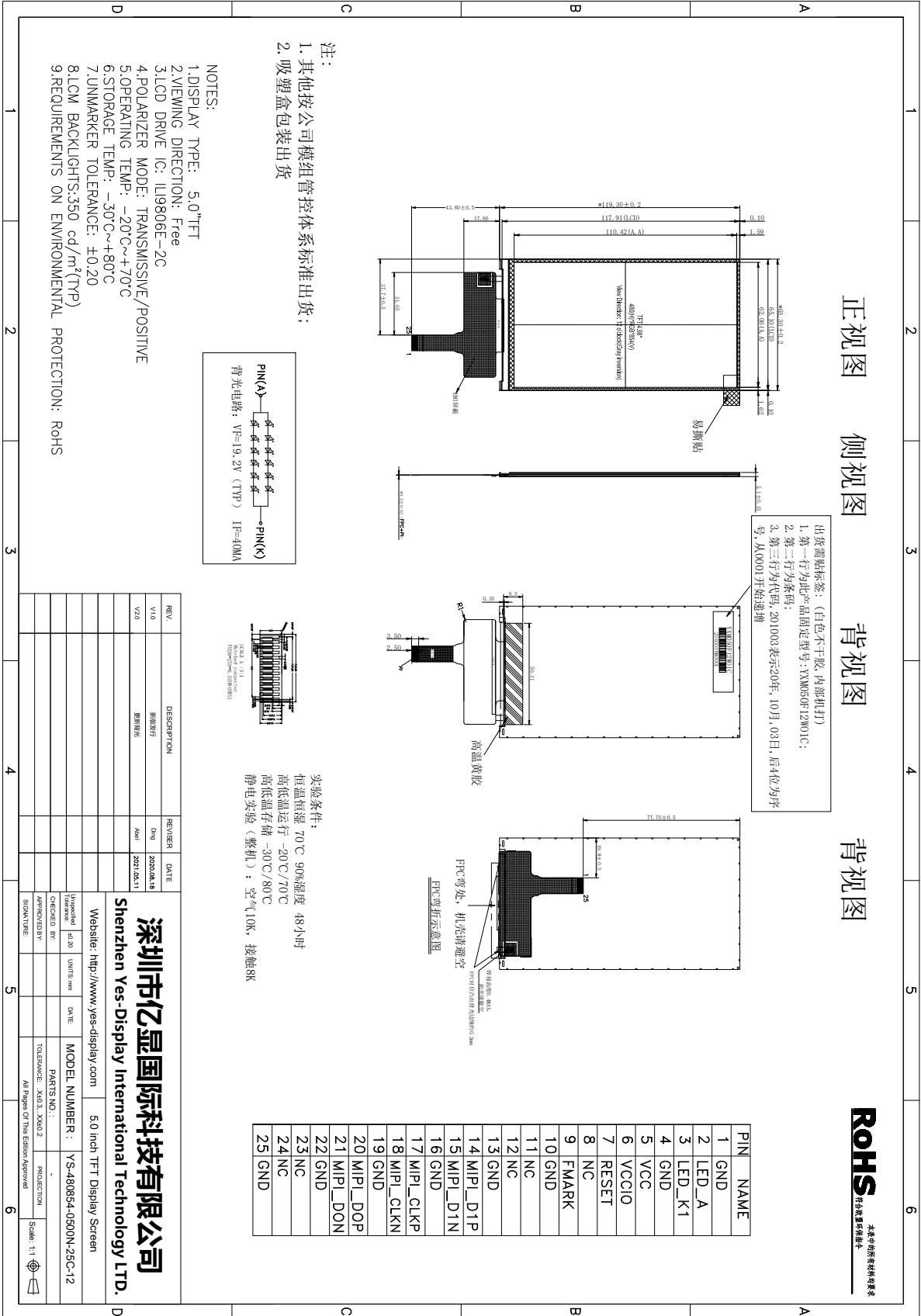

## 4. Input terminal Pin Assignment Description

### 4.1 TFT PIN

PIN NO.	PIN NAME	DESCRIPTION
1	GND	Ground for logic.
2	LED_A	Power supply for backlight anode input terminal.
3	LED_K	Power supply for backlight cathode input terminal.
4	GND	Ground for logic.
5	VCC	VCC power input
6	IOVCC	IO System power supply
7	RESET	Reset signal input terminal, active at 'L'.
8	NC	NC
9	FMARK	TE signal
10	GND	Ground for logic.
11-12	NC	NC
13	GND	Ground for logic.
14	MIPI_D1P	DATA1+ differential data signals.
15	MIPI_D1N	DATA1- differential data signals.
16	GND	Ground for logic.
17	MIPI_CLKP	CLK+ differential clock signals
18	MIPI_CLKN	CLK- differential clock signals.
19	GND	Ground for logic.
20	MIPI_D0P	DATA0+ differential data signals.
21	MIPI_D0N	DATA0- differential data signals.
22	GND	Ground for logic.
23-24	NC	NC
25	GND	Ground for logic.

File NO.

REV

A/01

<http://www.yes-display.com>

## 5. LCD Optical Characteristics

Item	Conditions		Min.	Typ.	Max.	Unit	Note
Transmittance	-		4.00	4.26	-	%	(1),(5),(6),(7),(8)
Contrast Ratio	Center		640	800	-	-	(1),(3),(6)(7)
Response Time	Rising + Falling		-	16	25	ms	(1),(4),(6),(7)
CF Color Chromaticity (CIE1931)	Red	x	Typ. -0.03	0.637	Typ. +0.03	-	Under C-light
	Red	y		0.338		-	
	Green	x		0.289		-	
	Green	y		0.589		-	
	Blue	x		0.136		-	
	Blue	y		0.143		-	
	White	x		0.300		-	
	White	y		0.340		-	
NTSC	CIE1931		57.0	60.0	-	%	(1),(6),(7)
Viewing Angle (CR>10)	Horizontal	$\theta_L$	60	70	-	degree	(1),(2),(6),(7)
		$\theta_R$	60	70	-		
	Vertical	$\theta_T$	60	70	-		
		$\theta_B$	50	60	-		
Viewing Direction	12 O'clock						(2).(9)



**Note (1) Measurement Setup:**

The LCD module should be stabilized at given temperature(25°C) for 15 minutes to avoid abrupt temperature change during measuring. In order to stabilize the luminance, the measurement should be executed after lighting backlight for 15 minutes in a windless room.

**Measurement Setup**

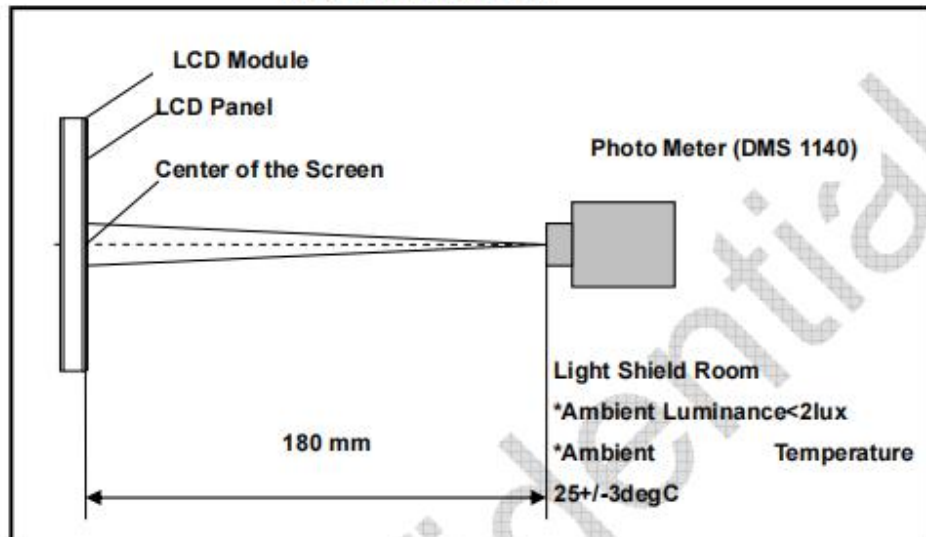

**Note (2) Definition of Viewing Angle**

**Definition of Viewing Angle**

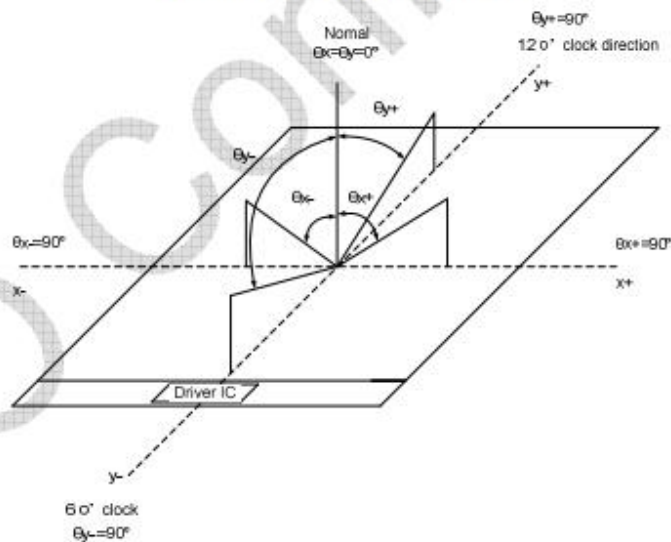

**Note (3) Definition Of Contrast Ratio (CR)**

The contrast ratio can be calculated by the following expression

$$\text{Contrast Ratio (CR)} = L_{255} / L_0$$

L255: Luminance of gray level 255, L0: Luminance of gray level 0

**Note (4) Definition Of Response Time**

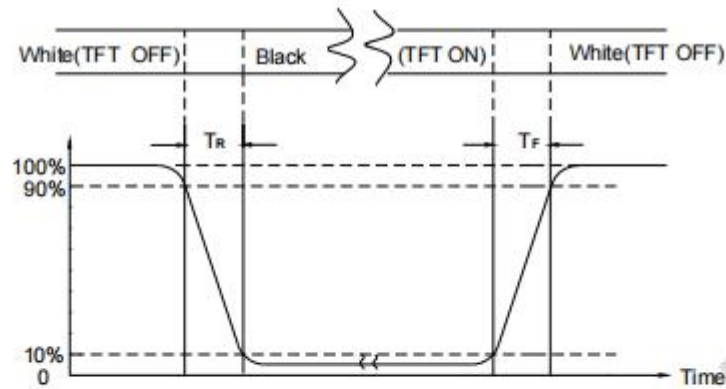

Note (5) Definition of Transmittance

$$\text{Transmittance} = \frac{\text{Center Luminance of LCD}}{\text{Center Luminance of Back Light}} \times 100\%$$

Note (6) Light source is the BLU which is supplied by IVO

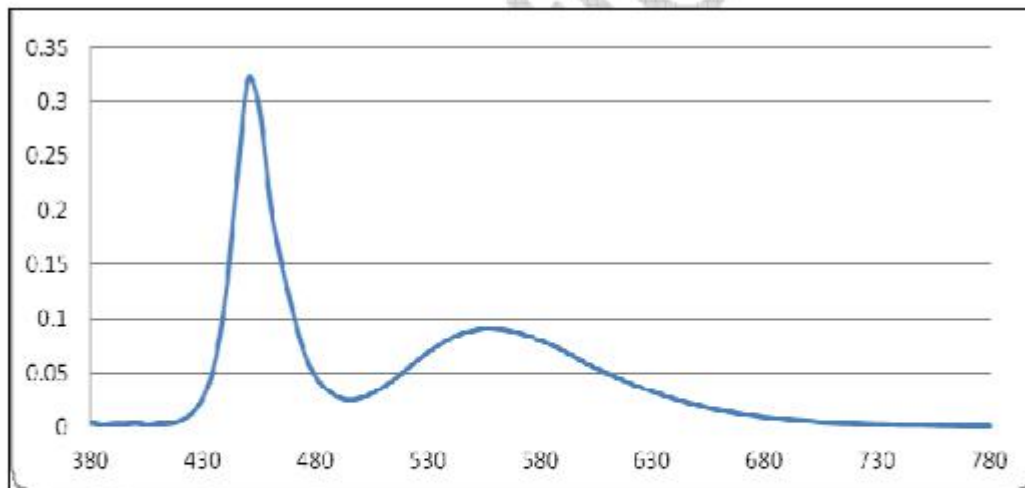



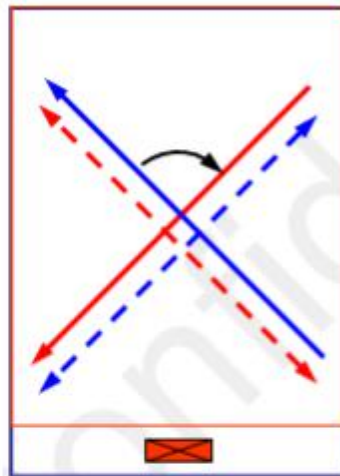

Note (7) The polarizer type: SLP-5215ASEWW-T/CF , SLP-5215AG6EWW-T/TFT.

Note (8) All optical data based on IVO given polarizer & Backlight & testing machine in this document.

Note (9) Rubbing Direction



Array Film Up  
CF Film Down

-  CF Side Polarizer Absorption Axis
-  TFT Side Polarizer Absorption Axis
-  CF Side Rubbing Direction
-  TFT Side Rubbing Direction

Rubbing Direction(12 o'clock)

深圳市亿显国际科技有限公司 ShenZhen Yes-Display International Technology CO.,LTD.			5.0 寸液晶显示屏 5.0 Inch LCD Display Screen	
File NO.		REV	A/01	<a href="http://www.yes-display.com">http://www.yes-display.com</a>

## 6. TFT Electrical Characteristics

### 6.1 Absolute Maximum Ratings

Item	Symbol	Min.	Max.	Unit
Logic Supply Voltage	VDD	-0.3	4.0	V
Input Voltage	Vin	-0.3	VDD+0.3	V
Operating Temperature	TOP	-20	70	°C
Storage Temperature	TST	-30	80	°C
Storage Humidity	HD	20	90	%RH

### 6.2 DC Characteristics

Item	Symbol	Min.	Typ.	Max.	Unit	Remark
Logic Supply Voltage	VDD	2.5	2.8	3.6	V	-
Input High Voltage	V <sub>IH</sub>	0.7VDD	-	VDD	V	-
Input Low Voltage	V <sub>IL</sub>	GND	-	0.3 VDD	V	-
Output High Voltage	V <sub>OH</sub>	0.8 VDD	-	VDD	V	-
Output Low Voltage	V <sub>OL</sub>	GND	-	0.2 VDD	V	-
I/O Leak Current	I <sub>LI</sub>	-1	-	1	uA	-
Supply Current	IDD	-	TBD	-	mA	-

### 6.3 LED Backlight Characteristics

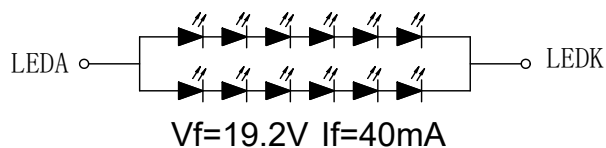

Item	Symbol	MIN	TYP	MAX	UNIT	Test Condition
Supply Voltage	V <sub>f</sub>	-	19.2	-	V	I <sub>f</sub> =40mA
Supply Current	I <sub>f</sub>	-	40	-	mA	-
Luminous Intensity for LCM	-	-	-	-	cd/m <sup>2</sup>	I <sub>f</sub> =40mA
Uniformity for LCM	-	-	60	-	%	I <sub>f</sub> =40mA
Life Time	-	-	50000	-	Hr	I <sub>f</sub> =40mA
Backlight Color	White					

## 7. Timing Characteristics

### 7.1 TFT Timing Characteristics

#### 7.1.1 Display Serial Interface Timing Characteristics (MIPI system)

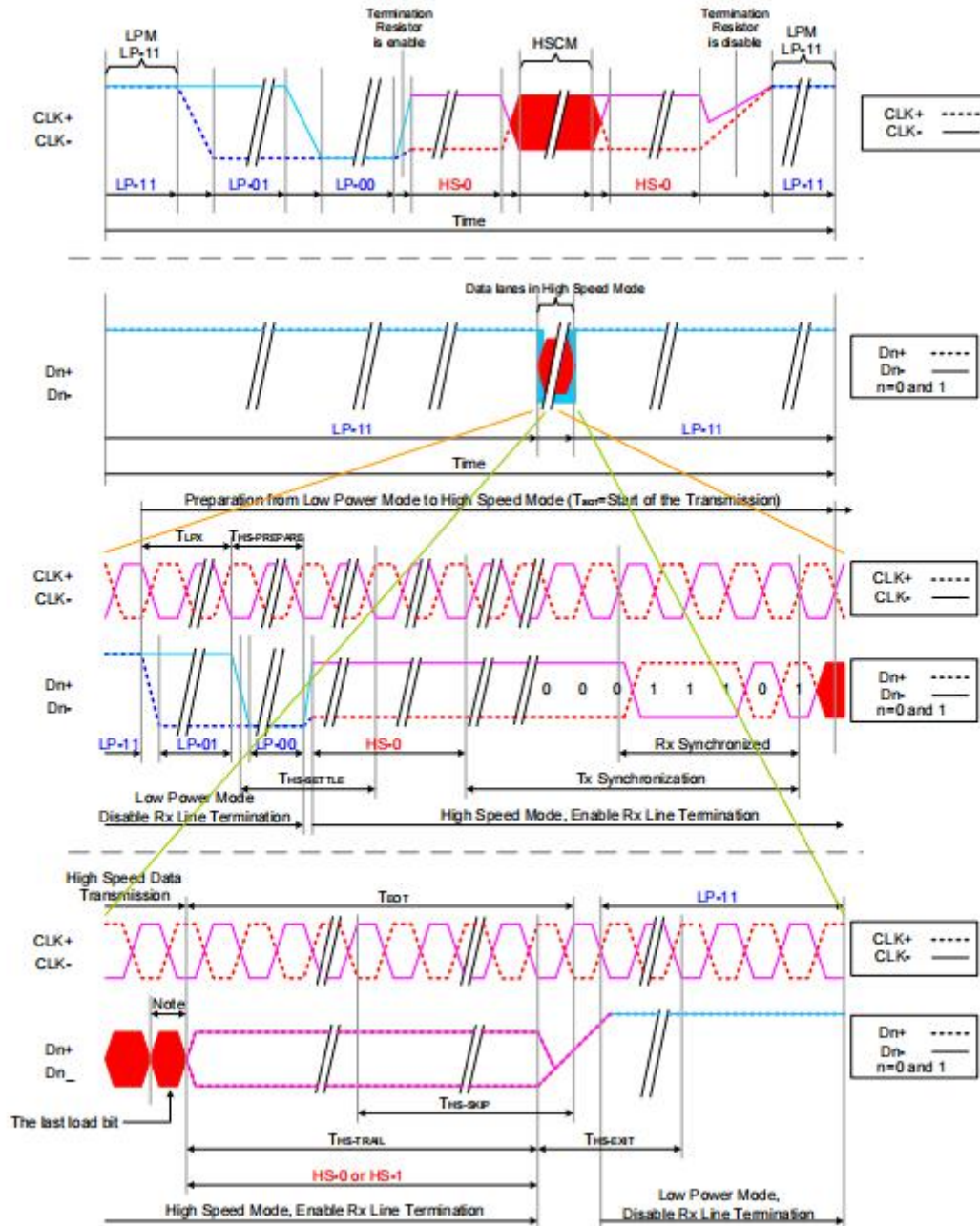

#### 7.1.2 Reset Timing Characteristics

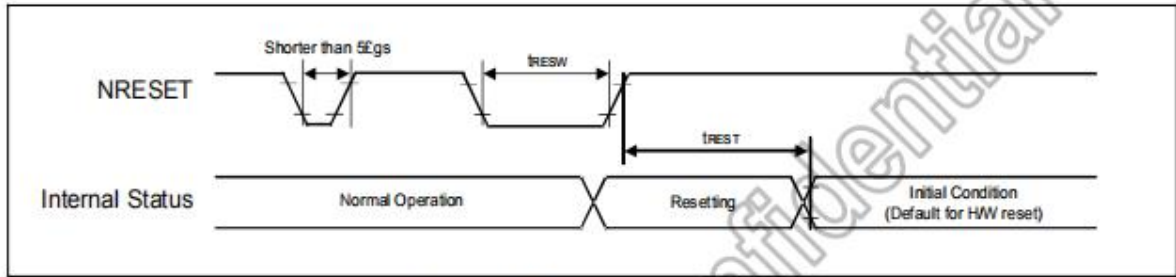

Figure 7.8: Reset input timing

Symbol	Parameter	Related Pins	Spec.			Note	Unit
			Min.	Typ.	Max.		
tRESW	Reset low pulse width <sup>(1)</sup>	NRESET	10	-	-	-	μs
tREST	Reset complete time <sup>(2)</sup>	-	15	-	-	When reset applied during SLPIN mode	ms
		-	120	-	-	When reset applied during SLPOUT mode	ms

Table 7.8: Reset Input Timing

### 7.1.3 Power on/off timing sequence check the IC datasheet!

## 7.2 TP Timing Characteristics

深圳市亿显国际科技有限公司 ShenZhen Yes-Display International Technology CO.,LTD.			5.0 寸液晶显示屏 <b>5.0 Inch LCD Display Screen</b>	
File NO.		REV	A/01	<a href="http://www.yes-display.com">http://www.yes-display.com</a>

## 8. Inspection Standard

### 8.1 Incoming Inspection and Standard:

The below incoming inspection are applied to the TFT LCM Modules supplied by ShenZhen Yes-Display International Technology CO.,LTD. The customers should inspect the LCM within 14 days after receiving the goods. The result of inspection should be notified to the Seller in the writing copy promptly, if the customer do not send them within 14 days, the seller has the right to judge as acceptance of goods. The inspection lot size is treated as the quantity per shipment and per model. The sampling plan shall be inspected under MIL-STD015E in Level II by single sampling. The acceptable quality level (AQL) are categorized as below grades:

CRITICAL= 0.4%, MAJOR= 0.65%, MINOR= 1.5%

### 8.2 Inspection condition and Warranty policy:

The delivered LCM should be stored properly, ideally under climate-controlled environment at 25 (±5) degree Celsius as well as 60% (±10) Relative Humidity. The LCM shall be inspected in the viewing angle of 45 degree from the four major angles (U/D/L/R) under the single fluorescent lamp of 20W (equal to 300 to 500 lux). For warranty, ShenZhen Yes-Display International Technology CO.,LTD. will provide 12 months of warranty period as standard, and provide the new replacement for the defective products which belong to the Seller's responsibility verified by the quality department.

### 8.3 Inspection Criteria:

#### 8.3.1 Critical defect

Item No.	Inspection content	Judgement
8.3.1.1	Functional defects	No display, abnormal display, short circuit, missing line, off-contrast and chromaticity, Touch Panel non-function
8.3.1.2	Model mixed	Other model mixed

#### 8.3.2 Major defect:

Item No.	Inspection content	Judgement
8.3.2.1	Product indication	Missing model no. and wrong model no. is indicated on the LCM.
8.3.2.2	Glass cracking	The LCD and touch panel glass crack or breakage

深圳市亿显国际科技有限公司 ShenZhen Yes-Display International Technology CO.,LTD.			5.0 寸液晶显示屏 <b>5.0 Inch LCD Display Screen</b>	
File NO.		REV	A/01	<a href="http://www.yes-display.com">http://www.yes-display.com</a>

8.3.2.3	Missing component	The function component missing such as connector, cable, etc.
---------	-------------------	---

**8.3.3 Minor defect (LCD) :**

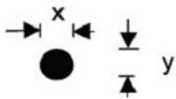
Item No.	Inspection content	Judgement												
8.3.3.1	<b>Black/White spot</b> <b>Foreign particles</b> <b>Dust in the cell</b>	$\varphi = (x+y) / 2$  <table border="1"> <thead> <tr> <th>Diameter (mm)</th> <th>Acceptable Q'ty</th> </tr> </thead> <tbody> <tr> <td><math>\Phi \leq 0.1</math></td> <td>Ignore</td> </tr> <tr> <td><math>0.1 &lt; \Phi \leq 0.25</math></td> <td>3 (Distance&gt;5mm)</td> </tr> <tr> <td><math>0.25 &lt; \Phi</math></td> <td>Not allowed</td> </tr> </tbody> </table>	Diameter (mm)	Acceptable Q'ty	$\Phi \leq 0.1$	Ignore	$0.1 < \Phi \leq 0.25$	3 (Distance>5mm)	$0.25 < \Phi$	Not allowed				
Diameter (mm)	Acceptable Q'ty													
$\Phi \leq 0.1$	Ignore													
$0.1 < \Phi \leq 0.25$	3 (Distance>5mm)													
$0.25 < \Phi$	Not allowed													
8.3.3.2	<b>Linear defect</b> <b>Black/white line</b> <b>Black/white scratch</b>	<table border="1"> <thead> <tr> <th>Length(mm)</th> <th>Width (mm)</th> <th>Acceptable Q'ty</th> </tr> </thead> <tbody> <tr> <td></td> <td><math>W \leq 0.03</math></td> <td>Ignore</td> </tr> <tr> <td><math>L \leq 5.0</math></td> <td><math>0.03 &lt; W \leq 0.07</math></td> <td>3</td> </tr> <tr> <td></td> <td><math>0.07 &lt; W</math></td> <td>Follow 8.3.3.1</td> </tr> </tbody> </table>	Length(mm)	Width (mm)	Acceptable Q'ty		$W \leq 0.03$	Ignore	$L \leq 5.0$	$0.03 < W \leq 0.07$	3		$0.07 < W$	Follow 8.3.3.1
Length(mm)	Width (mm)	Acceptable Q'ty												
	$W \leq 0.03$	Ignore												
$L \leq 5.0$	$0.03 < W \leq 0.07$	3												
	$0.07 < W$	Follow 8.3.3.1												
8.3.3.3	<b>Polarizer Bubbles</b> <b>Dent on polarizer</b>	<table border="1"> <thead> <tr> <th>Diameter (mm)</th> <th>Acceptable Q'ty</th> </tr> </thead> <tbody> <tr> <td><math>\Phi \leq 0.2</math></td> <td>Ignore</td> </tr> <tr> <td><math>0.2 &lt; \Phi \leq 0.5</math></td> <td>2 (Distance&gt;5mm)</td> </tr> <tr> <td><math>0.5 &lt; \Phi</math></td> <td>Not allowed</td> </tr> </tbody> </table>	Diameter (mm)	Acceptable Q'ty	$\Phi \leq 0.2$	Ignore	$0.2 < \Phi \leq 0.5$	2 (Distance>5mm)	$0.5 < \Phi$	Not allowed				
Diameter (mm)	Acceptable Q'ty													
$\Phi \leq 0.2$	Ignore													
$0.2 < \Phi \leq 0.5$	2 (Distance>5mm)													
$0.5 < \Phi$	Not allowed													

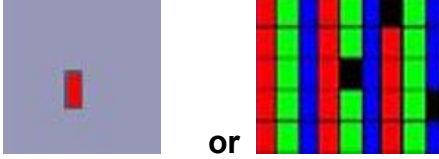
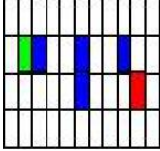
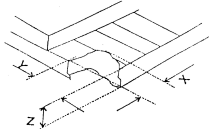
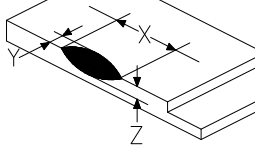

<p>8.3.3.4</p>	<p>Electrical Defect Dot</p>	<p>Bright dot and Dark dot definition:</p>  <p>or</p>  <p>(Two adjacent dot)</p> <p>Inspection pattern: black, white, red, green, and blue screen.</p> <table border="1" data-bbox="730 730 1441 913"> <thead> <tr> <th>Items</th> <th>Acceptable Q'ty</th> </tr> </thead> <tbody> <tr> <td>Bright dot</td> <td><math>N \leq 4</math> (Distance &gt;5mm)</td> </tr> <tr> <td>Dark dot</td> <td><math>N \leq 4</math> (Distance &gt;5mm)</td> </tr> </tbody> </table>	Items	Acceptable Q'ty	Bright dot	$N \leq 4$ (Distance >5mm)	Dark dot	$N \leq 4$ (Distance >5mm)
Items	Acceptable Q'ty							
Bright dot	$N \leq 4$ (Distance >5mm)							
Dark dot	$N \leq 4$ (Distance >5mm)							
<p>8.3.3.5</p>	<p>Glass Defect- Corner chipping</p>	 <table border="1" data-bbox="730 1104 1441 1375"> <thead> <tr> <th>Size(mm)</th> <th>Judgement</th> </tr> </thead> <tbody> <tr> <td> <math>X \leq 3\text{mm}</math>, <math>Y \leq S</math>,  <math>Z \leq T</math>                      (S= ITO length,                      T=Single glass thickness)                 </td> <td>Accept</td> </tr> </tbody> </table>	Size(mm)	Judgement	$X \leq 3\text{mm}$ , $Y \leq S$ , $Z \leq T$ (S= ITO length, T=Single glass thickness)	Accept		
Size(mm)	Judgement							
$X \leq 3\text{mm}$ , $Y \leq S$ , $Z \leq T$ (S= ITO length, T=Single glass thickness)	Accept							
<p>8.3.3.6</p>	<p>Glass Defect- Side fragment</p>	 <table border="1" data-bbox="730 1574 1441 1787"> <thead> <tr> <th>Size(mm)</th> <th>Judgement</th> </tr> </thead> <tbody> <tr> <td> <math>X \leq 2 \text{ mm}</math>, <math>Y \leq \text{border edge}</math>  <math>Z \leq T</math>                      (T= single glass thickness)                 </td> <td>Accept</td> </tr> </tbody> </table>	Size(mm)	Judgement	$X \leq 2 \text{ mm}$ , $Y \leq \text{border edge}$ $Z \leq T$ (T= single glass thickness)	Accept		
Size(mm)	Judgement							
$X \leq 2 \text{ mm}$ , $Y \leq \text{border edge}$ $Z \leq T$ (T= single glass thickness)	Accept							

8.3.4 Minor defect (Touch Panel)

Item No.	Inspection content	Judgement
----------	--------------------	-----------

File NO.

REV

A/01

<http://www.yes-display.com>

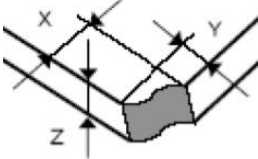
8.3.4.1	Scratch, dust, particles, foreign materials in "linear type"	Size (mm)	Acceptable Q'ty
		$W \leq 0.05\text{mm}, L \leq 10\text{mm}$	Ignore
		$0.05\text{mm} < W \leq 0.07\text{mm}, L \leq 10\text{mm}$	3
		$W > 0.07\text{mm}$	Reject
8.3.4.2	Scratch, dust, particles, foreign materials in "round type"	Diameter (mm)	Acceptable Q'ty
		$\Phi \leq 0.25\text{mm}$	Ignore
		$0.25\text{mm} < \Phi \leq 0.35\text{mm}$	5
		$\Phi > 0.35\text{mm}$	Reject
8.3.4.3	Air bubbles	Diameter (mm)	Acceptable Q'ty
		$\Phi \leq 0.2\text{mm}$	Ignore
		$0.2\text{mm} < \Phi \leq 0.5\text{mm}$	3
		$\Phi > 0.5\text{mm}$	Reject
8.3.4.5	Scratch on printing area	Size (mm)	Acceptable Q'ty
		$W \leq 0.03\text{mm}, L \leq 5\text{mm}$	Ignore
		$0.03\text{mm} < W \leq 0.05\text{mm}, L \leq 5\text{mm}$	3
		$W > 0.05\text{mm}$ or $L > 5\text{mm}$	Reject
8.3.4.6	Corner chipping		
		Size(mm)	Judgement
		$X \leq 2\text{mm}, Y \leq 2\text{mm}$ $Z < 1/2T$ (T= single glass thickness)	Accept

File NO.

REV

A/01

<http://www.yes-display.com>

8.3.4.7

Edge chipping

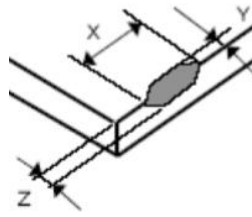

Size(mm)	Judgement
$X \leq 3 \text{ mm}$ , $Y \leq 3 \text{ mm}$ $Z \leq 1/2 T$ (T= single glass thickness)	Accept

深圳市亿显国际科技有限公司 ShenZhen Yes-Display International Technology CO.,LTD.			5.0 寸液晶显示屏 5.0 Inch LCD Display Screen	
File NO.		REV	A/01	<a href="http://www.yes-display.com">http://www.yes-display.com</a>

## 9. Reliability Test Conditions and Methods

### 9.1 Reliability Test Conditions and Methods:

NO.	TEST ITEMS	TEST CONDITION	INSPECTION AFTER TEST
①	High Temperature Storage	80°C±2°C×96Hours	Inspection after 2~4hours storage at room temperature, the samples should be free from defects: 1, Air bubble in the LCD. 2, Seal leak. 3, Non-display. 4, Missing segments. 5, Glass crack. 6, Current IDD is twice higher than initial value. 7, The surface shall be free from damage. 8, The electric characteristic requirements shall be satisfied.
②	Low Temperature Storage	-30°C±2°C×96Hours	
③	High Temperature Operating	70°C±2°C×96Hours	
④	Low Temperature Operating	-20°C±2°C×96Hours	
⑤	Temperature Cycle(Storage)	-20°C ↔ 25°C ↔ 70°C (30min) ← (5min) → (30min) 1cycle Total 10cycle	
⑥	Damp Proof Test (Storage)	50°C±5°C×90%RH×96Hours	
⑦	Vibration Test	Frequency:10Hz~55Hz~10Hz Amplitude:1.5MM X,Y,Z direction for total 3hours (packing condition test will be tested by a carton)	
⑧	Drooping Test	Drop to the ground from 1M height one time every side of carton. (packing condition test will be tested by a carton)	
⑨	ESD Test	Voltage:±8KV,R:330Ω,C:150PF,Air Mode,10times	

<b>深圳市亿显国际科技有限公司</b> <b>ShenZhen Yes-Display International Technology CO.,LTD.</b>			<b>5.0 寸液晶显示屏</b> <b>5.0 Inch LCD Display Screen</b>	
<b>File NO.</b>		<b>REV</b>	<b>A/01</b>	<b><a href="http://www.yes-display.com">http://www.yes-display.com</a></b>

**REMARK:**

- 1, The Test samples should be applied to only one test item.
- 2, Sample side for each test item is 5~10pcs.
- 3, For Damp Proof Test, Pure water(Resistance > 10MΩ) should be used.
- 4, In case of malfunction defect caused by ESD damage, if it would be recovered to normal state after resetting, it would be judge as a good part.
- 5, EL evaluation should be accepted from reliability test with humidity and temperature: Some defects such as black spot/blemish can happen by natural chemical reaction with humidity and Fluorescence EL has.
- 6, Failure Judgment Criterion: Basic Specification Electrical Characteristic, Mechanical Characteristic, Optical Characteristic.

深圳市亿显国际科技有限公司 ShenZhen Yes-Display International Technology CO.,LTD.			5.0 寸液晶显示屏 <b>5.0 Inch LCD Display Screen</b>	
File NO.		REV	A/01	<a href="http://www.yes-display.com">http://www.yes-display.com</a>

## 10. Cautions and Handling Precautions

### 10.1 Mounting method

The LCD panel of TFT module consists of two thin glass plates with polarizes which easily be damaged. And since the module in so constructed as to be fixed by utilizing fitting holes in the printed circuit board.

Extreme care should be needed when handling the LCD modules.

### 10.2 Caution of LCD handling and cleaning

When cleaning the display surface, Use soft cloth with solvent

[Recommended below] and wipe lightly

- Isopropyl alcohol
- Ethyl alcohol

Do not wipe the display surface with dry or hard materials that will damage the polarizer surface.

Do not use the following solvent:

- Water
- Aromatics

Do not wipe ITO pad area with the dry or hard materials that will damage the ITO patterns

Do not use the following solvent on the pad or prevent it from being contaminated:

- Soldering flux
- Chlorine (Cl) , Sulfur (S)

If goods were sent without being silicon coated on the pad, ITO patterns could be damaged due to the corrosion as time goes on.

If ITO corrosion happen by miss-handling or using some materials such as Chlorine (Cl), Sulfur (S) from customer, Responsibility is on customer.

### 10.3 Caution against static charge

The LCD module use C-MOS LSI drivers, so we recommended that you:

Connect any unused input terminal to power or ground, do not input any signals before power is turned on, and ground your body, work/assembly areas, and assembly equipment to protect against static electricity.

深圳市亿显国际科技有限公司 ShenZhen Yes-Display International Technology CO.,LTD.			5.0 寸液晶显示屏 <b>5.0 Inch LCD Display Screen</b>	
File NO.		REV	A/01	<a href="http://www.yes-display.com">http://www.yes-display.com</a>

## 10.4 packing

- Module employs LCD elements and must be treated as such.
- Avoid intense shock and falls from a height.
- To prevent modules from degradation, do not operate or store them exposed direct to sunshine or high temperature/humidity

## 10.5 Caution for operation

- It is an indispensable condition to drive LCD's within the specified voltage limit since the higher voltage then the limit cause the shorter LCD life.
- An electrochemical reaction due to direct current causes LCD's undesirable deterioration, so that the use of direct current drive should be avoided.
- Response time will be extremely delayed at lower temperature then the operating temperature range and on the other hand at higher temperature LCD's how dark color in them. However those phenomena do not mean malfunction or out of order with LCD's, which will come back in the specified operation temperature.
- If the display area is pushed hard during operation, some font will be abnormally displayed but it resumes normal condition after turning off once.
- Slight dew depositing on terminals is a cause for electro-chemical reaction resulting in terminal open circuit.

Usage under the maximum operating temperature, 50%Rh or less is required.

## 10.6 storing

In the case of storing for a long period of time for instance, for years for the purpose or replacement use, the following ways are recommended.

- Storage in a polyethylene bag with the opening sealed so as not to enter fresh air outside in it. And with no desiccant.
- Placing in a dark place where neither exposure to direct sunlight nor light's keeping the storage temperature range.
- Storing with no touch on polarizer surface by the anything else.

[It is recommended to store them as they have been contained in the inner container at the time of delivery from us

## 10.7 Safety

- It is recommendable to crash damaged or unnecessary LCD's into pieces and wash off liquid crystal by either of solvents such as acetone and ethanol, which should be burned up later.

<b>深圳市亿显国际科技有限公司</b> <b>ShenZhen Yes-Display International Technology CO.,LTD.</b>			<b>5.0 寸液晶显示屏</b> <b>5.0 Inch LCD Display Screen</b>	
<b>File NO.</b>		<b>REV</b>	<b>A/01</b>	<b><a href="http://www.yes-display.com">http://www.yes-display.com</a></b>

- When any liquid leaked out of a damaged glass cell comes in contact with your hands, please wash it off well with soap and water



## 11. Packing Method

### 11.1 Method

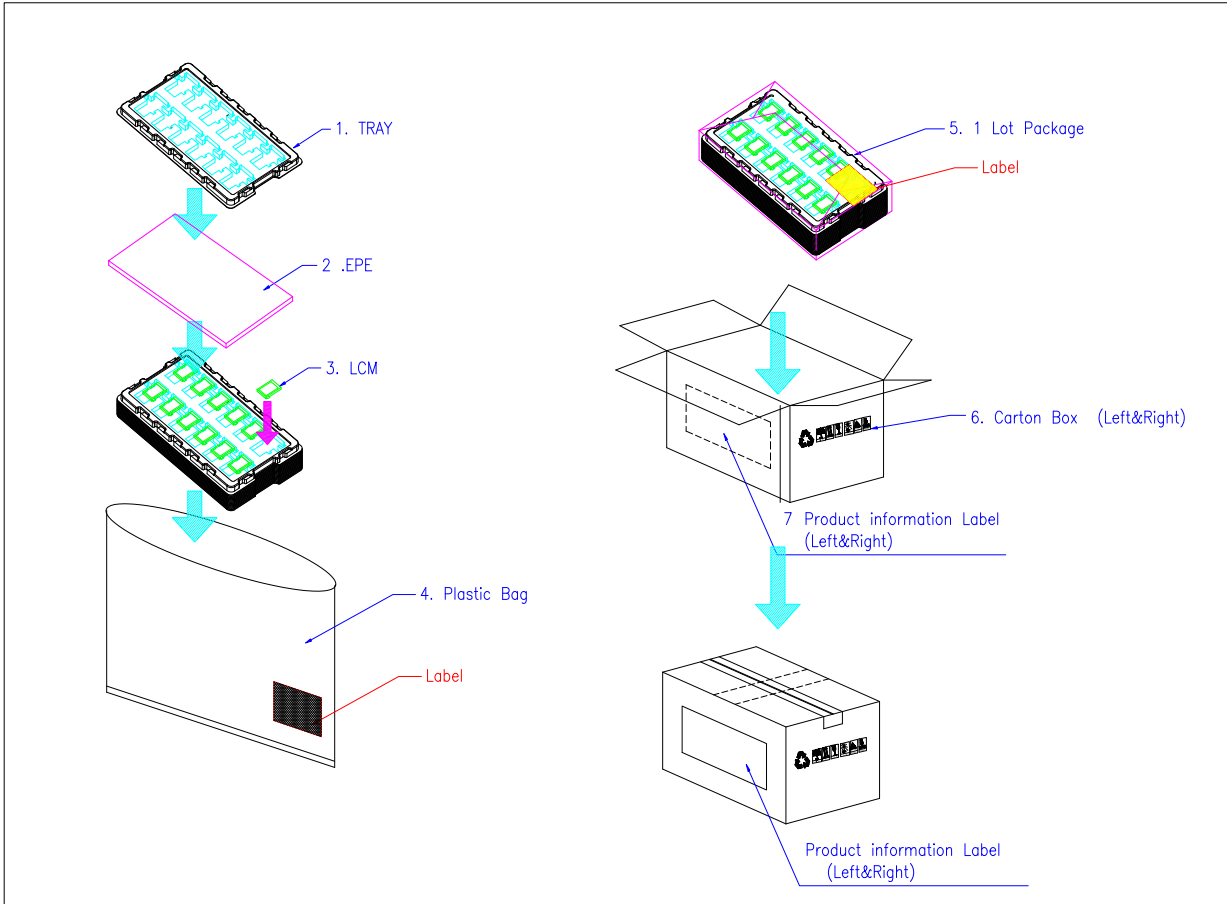

### 11.2 Packing Label

TBD